



Elektromotoren  
Läutemaschinen  
Kirchturmuhren

# Operating manual

Electric motors  
ATEX / IECEx

Size 71 - 132  
B\_Ex 71 – 132 with brake

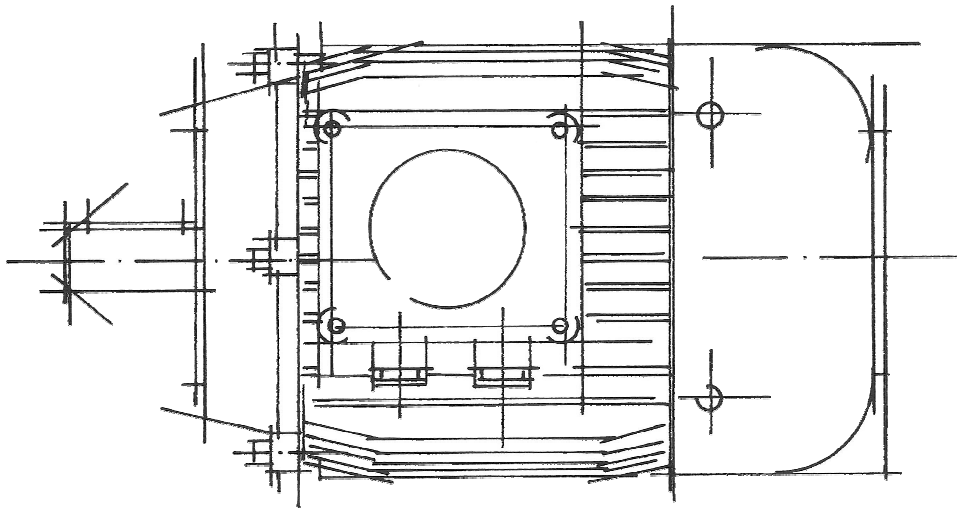

© Herforder Elektromotoren-Werke  
GmbH & Co. KG  
Goebenstr. 106  
32051 Herford  
Germany

Tel.: +49 (0) 5221 5904-0  
Fax: +49 (0) 5221 5904-34

E-Mail: [info@hew-hf.de](mailto:info@hew-hf.de)  
Internet: [www.hew-hf.de](http://www.hew-hf.de)

Release: 01 / 25/03/2015

Created by:  
Kothes!  
Technische Kommunikation GmbH & Co. KG  
[www.kothes.de](http://www.kothes.de)

This issue replaces all previous issues. All previous  
issues are invalid. The date of issue (⇒ footer) is  
authoritative.

<b>1</b>	<b>General information .....</b>	<b>5</b>
1.1	Information on this operating manual.....	5
1.2	Explanation of symbols.....	6
1.3	Limitation of liability .....	7
1.4	Copyright.....	8
1.5	Spare parts.....	8
1.6	Warranty conditions.....	8
1.7	Customer service .....	8
<b>2</b>	<b>Safety .....</b>	<b>9</b>
2.1	Responsibility of the user .....	9
2.2	Staff requirements .....	10
2.2.1	Qualifications.....	10
2.2.2	Unauthorised parties .....	12
2.2.3	Training.....	12
2.3	Proper use.....	12
2.4	Personal safety equipment and clothing .....	13
2.5	Special hazards.....	14
2.6	Safety devices .....	17
2.7	Securing the machine to prevent it from being switched back on.....	17
2.8	How to act in case of hazards and accidents.....	18
2.9	Environmental protection.....	19
<b>3</b>	<b>Technical data .....</b>	<b>20</b>
3.1	Operating conditions .....	20
3.2	Type plate .....	20
3.3	Explosion protection marking.....	21
<b>4</b>	<b>Construction and function .....</b>	<b>23</b>
4.1	Overview of sizes 71 to 132.....	23
4.2	Description of the brake.....	24
4.2.1	General description .....	24
4.2.2	Assignment and technical data .....	24
4.3.	Connection and protection of the motor or brake	24
4.4	Obligations and conditions .....	25
4.5	Operation on the frequency inverter .....	26
<b>5</b>	<b>Transportation, packaging and storage .....</b>	<b>28</b>



## Table of contents

5.1	Delivery inspection .....	29
5.2	Transportation .....	30
5.3	Packaging .....	31
5.4	Storage.....	32
<b>6</b>	<b>Installation and commissioning .....</b>	<b>33</b>
6.1	Safety .....	33
6.2	Installation .....	35
6.2.1	Ventilation at the location for use .....	35
6.2.2	Types of construction as per EN 60034-7 ....	35
6.2.3	Erecting the machine .....	38
6.2.4	Installation.....	38
6.3	Connecting to the energy supply .....	39
6.3.1	Screwed cable gland .....	39
6.3.2	Voltage and circuit .....	40
6.3.3	Checking the insulation resistance .....	41
6.4	Commissioning.....	41
<b>7</b>	<b>Operations .....</b>	<b>43</b>
7.1	General information .....	43
7.2	Shutting down in an emergency.....	43
<b>8</b>	<b>Faults .....</b>	<b>44</b>
8.1	Safety .....	44
8.2	Fault table .....	46
8.3	Commissioning after remedied fault .....	49
<b>9</b>	<b>Maintenance.....</b>	<b>50</b>
9.1	Safety .....	50
9.2	Cleaning .....	52
9.3	Maintenance schedule.....	52
9.4	Tightening torque values for screws .....	53
9.4.1	Tightening torque values for screws for electrical connections .....	54
9.4.2	Screw connections, property class 8.8 and A4-70 .....	54
9.4.3	Screw connections of property class 5.6.....	54
9.5	Measures on completion of maintenance .....	55
<b>10</b>	<b>Removal.....</b>	<b>56</b>
10.1	Safety .....	56
10.2	Removal .....	57
10.3	Disposal .....	58

# 1 General information

## 1.1 Information on this operating manual

This operating manual makes it possible to handle the machine safely and efficiently.

The manual is a component of the machine and must be kept in the direct vicinity of the plant and be accessible to staff at all times. Staff must have carefully read and understood this manual before starting all work. Adherence to all the specified safety instructions and instructions for actions in this operating manual is a fundamental requirement for working safely.

The local regulations for the prevention of accidents and the general safety regulations for the location in which the machine is used also apply.

The illustrations in this operating manual are for purposes of general understanding and may differ from the actual machine version.



## 1.2 Explanation of symbols

### Safety instructions

The safety instructions in this manual are indicated by symbols. The safety instructions are introduced by signal words which express the extent of the risk.

It is imperative to adhere to safety instructions and act with caution in order to prevent accidents, personal injury and material damage.



#### **DANGER!**

... indicates an immediately dangerous situation which will lead to death or serious injuries if not avoided.



#### **WARNING!**

... indicates a possibly dangerous situation which may lead to death or serious injuries if not avoided.



#### **CAUTION!**

... indicates a possibly dangerous situation which may lead to minor or light injuries if not avoided.



#### **CAUTION!**

... indicates a possibly dangerous situation which may lead to material damage if not avoided.

### Tips and recommendations



#### **NOTE!**

... draws attention to tips and recommendation and information for efficient, fault-free operation.

## Special safety instructions

The following symbols are used in safety instructions in order to point out particular hazards.



... indicates risks from electrical current. Failure to observe the safety instructions will result in the risk of serious or fatal injury.



### **EXPLOSION PROTECTION!**

... indicates content and instructions in this operating manual which apply when using this machine in potentially explosive areas as per the ATEX directive. Failure to observe this content and these instructions can lead to a loss of explosion protection.

## 1.3 Limitation of liability

All the information and instructions in this manual have been compiled in line with the valid standards and regulations, state-of-the-art technology and our many years of experience and know-how.

The manufacturer shall not be liable for damages caused by:

- Failure to observe the manual
- Improper use
- Employment of unqualified staff
- Arbitrary modifications
- Technical changes
- Use of non-approved spare parts

In case of special versions, the utilisation of additional order options or due to new technical changes, the actual scope of delivery may differ from the explanations described here and the illustrations.

The obligations agreed in the delivery contract, the General terms and Conditions and the Terms and Conditions of Delivery of the manufacturer, and the legal regulations valid at the point of completion of the contract apply.

We reserve the right to make technical changes within the scope of further development and improvement of the performance characteristics.



## 1.4 Copyright

This operating manual is protected by copyright and for internal use only.

The manual must not be made available to third parties, reproduced in any way (including excerpts), its content must not be utilised and/or communicated without the written approval of the manufacturer, except for internal purposes.

Failure to comply will render the offender liable for damages. We reserve the right to further claims.

## 1.5 Spare parts

### Explosion protection



#### **EXPLOSION PROTECTION!**

The use of incorrect or faulty spare parts can use to explosions in the potentially explosive area.

Therefore:

- Only use the manufacturer's original spare parts or spare parts expressly approved by the manufacturer.
- Always contact the manufacturer in case of any uncertainty.

Failure to adhere to these instructions will lead to a loss of the explosion protection.

Purchase spare parts from authorised dealers or directly from the manufacturer. See page 2 for the address.

The spare parts list can be found on page 22.

## 1.6 Warranty conditions

The warranty conditions are included in the manufacturer's General Terms and Conditions.

## 1.7 Customer service

Our customer service department is available to provide technical information. See page 2 for contact details.

Furthermore our staff are always interested in receiving new information and hearing of new experiences gained from the use of our products which can be used to improve our products.



## 2 Safety

This section provides you with an overview of all important aspects of safety required for providing staff with optimum protection as well as safe, fault-free operation.

Failure to observe the instructions and safety instructions for actions in this operating manual can cause considerable risks.

### 2.1 Responsibility of the user

The machine is used in the commercial field. The user of the machine is therefore subject to the legal obligations for occupational safety.

In addition to the safety instructions in this manual, the regulations for safety, accident prevention and environmental protection which apply at the location for use of the machine must also be observed. The following in particular applies:

- The user must fully acquaint himself with the valid occupational safety regulations and, in addition, carry out a risk assessment to determine the hazards which result from the particular working conditions at the location in which the machine is used. The results must be implemented as a set of operating instructions for operation of the machine.
- The user must carry out checks during the entire period of its use to determine whether the operating instructions drawn up are in line with the current regulations and adjust them as necessary.
- The user must clearly set out the responsibilities for installation, operation, maintenance and cleaning.
- The user must make sure that all staff involved with work on the machine have read and understood the manual. Furthermore, staff must be provided with regular training and information on the following points:
  - Fire and explosion hazards at the machine's location for use and the immediate vicinity.
  - Local fire and explosion protection measures.
  - Location and function of protective equipment.
  - The necessity of a ban on smoking.
  - The necessity of avoiding open fire.
  - Procedure for cleaning and maintenance work and repairs, including tools, aids and cleaning agents to be used.
  - The necessity of wearing personal safety equipment and clothing which is suitable for the potentially explosive environment.
- The user must adhere to the further obligations of Directive 99/92/EC for the improvement of health and safety measures



and the safety of employees who may be at risk from a potentially explosive atmosphere. This includes adherence to further organisational measures, such as:

- marking potentially explosive areas.
  - drawing up an explosion protection document for each zone.
  - denying unauthorised parties access.
  - putting up clear signs indicating all restraints.
  - introduction of a permit procedure for carrying out dangerous work.
- The user must provide staff with the required safety clothing and equipment.

The user is also responsible for ensuring that the machine is kept in technically perfect condition. The following applies:

- The user must make sure that the maintenance intervals described in the operating manual are adhered to. Reduce the intervals accordingly in case of above average strain.
- The user must have all the safety devices checked regularly to make sure they are complete and fully functional.

## Loss of explosion protection



### EXPLOSION PROTECTION!

On machines which are designed to be installed in plants for operation in potentially explosive areas, as defined by Directive 2014/34/EU, the user must make sure that the directive is adhered to for the entire plant.

Failure to comply will lead to a loss of the explosion protection.

## 2.2 Staff requirements

### 2.2.1 Qualifications



### WARNING!

**Risk of injuries in case of insufficiently qualified staff.**

Improper use can cause considerable personal injury and material damage.

Therefore:

- Have all tasks performed by staff with the appropriate qualifications only.

The following levels of qualification are named in the operating manual for various ranges of tasks.

- **Trained person**  
has been informed of the tasks with which he has been

entrusted and the possible risks in case of incorrect behaviour in training measures provided by the user.

■ **Specialist staff**

are capable of carrying out the work with which they have been entrusted and recognising the potential risks independently because of their specialist qualifications, knowledge and experience, and knowledge of the valid regulations.

■ **Qualified electrician**

is capable of carrying out the work on electrical equipment and recognising and preventing the potential risks independently because of their specialist qualifications, knowledge and experience, and knowledge of the valid standards and regulations.

The qualified electrician is qualified to work in the specific area in which he works and is familiar with the relevant standards and regulations.

■ **Qualified specialist for the potentially explosive area**

is capable of carrying out the work on plants or components in the potentially explosive area and recognising the potential risks independently because of their specialist qualifications, knowledge and experience, and knowledge of the valid standards and regulations.

The qualified specialist has knowledge of the various ignition protection types, installation procedures and area classifications in potentially explosive spaces, and certification for the purported experience and knowledge.

The person is familiar with the relevant rules and regulations for the work and explosion protection, in particular but not exclusively, ATEX directive 2014/34/EU and the pertaining EN 60079 standard as well as the IECEx standard IEC 60079.

Staff should be made up exclusively of people who can be expected to carry out their work reliably. People whose reactions are influenced, for instance, by drugs, alcohol or medication, must not be allowed.

- When selecting staff adhere to the valid local regulations relating to age and profession.



## 2.2.2 Unauthorised parties



### WARNING!

#### Danger for unauthorised parties.

Unauthorised persons who do not meet with the requirements described here are not familiar with the hazards in the working area.

Therefore:

- Keep unauthorised persons away from the working area.
- In case of doubt, approach these persons and instruct them to leave the working area.
- Stop work until any unauthorised parties have left the working area.

## 2.2.3 Training

Staff must be provided with regular training by the user. Training must be logged to keep better track.

Date	Name	Type of training	Training provided by	Signature

Fig. 1

## 2.3 Proper use

The machine has been engineered and designed exclusively for the proper use described in this documentation.

The machine is used exclusively as a drive in commercial high voltage systems.

Proper use also includes adherence to all the stipulations of this manual.

Any other type of use, or use of the machine going beyond this use is considered improper use and can cause dangerous situations.

**WARNING!****Danger from improper use.**

Improper use of the machine can cause dangerous situations.

Take particular care not to use the machine as follows:

- Operation beyond the original designated application.
- Operation of machines in potentially explosive areas which do not have explosion protection markings and are thus not suitable for use in a potentially explosive atmosphere (⇒ Chapter "Explosion protection marking").

Claims of any kind for damages caused by improper use are null and void.

The user carries sole liability for any damages in case of improper use.

## 2.4 Personal safety equipment and clothing

Whilst work is being carried out, personal safety equipment and clothing must be worn in order to minimise health hazards.

- Always wear safety clothing and equipment required for the respective task whilst working.
- Follow the instructions in the working area on personal safety equipment and clothing.

### To be worn for all work

The following must be worn for all work:



#### Occupational safety clothing

is close-fitting working clothing with a low tear strength, close-fitting sleeves and no protruding parts. It serves primarily as protection from entanglement in moving machine parts.

Do not wear rings, chains or other jewellery.



#### Safety shoes

to protect from heavy falling parts and from slipping on slippery surfaces.



### To be worn for special tasks

When carrying out special tasks, special safety equipment and clothing is required. Reference is made to this in the individual chapters of this manual. These special items of safety clothing and equipment are explained in the following:



#### Light breathing mask

to protect from harmful dust.

## 2.5 Special hazards

The following section points out residual risks which have been determined by a risk analysis.

- Adhere to the safety instructions listed here and the warnings in other chapters in order to reduce health hazards and prevent dangerous situations.

### Explosion protection



#### EXPLOSION PROTECTION!

The introduction of ignition sources such as sparks, open flames and hot surfaces can cause explosions in the potentially explosive area. Therefore, when carrying out all work on the machine in the potentially explosive area:

- Do not start any work without a written permit.
- Only carry out work to the exclusion of a potentially explosive atmosphere.
- Only use tools which are approved for use in the potentially explosive area.

Failure to adhere to these instructions will lead to a loss of the explosion protection.

## Electrical current



### **DANGER!**

#### **Danger to life from electrical current.**

There is an immediate risk of fatal injury in case of contact with live parts. Damage to the insulation or individual components can mean danger to life.

Therefore:

- In case of damage to the insulation, switch off the power supply immediately and have repairs carried out.
- Have work on the electrical equipment carried out by qualified electricians only.
- When any work is carried out on the electrical equipment, disconnect it from the power and make sure it is free of voltage.
- Before carrying out maintenance, cleaning and repair work, switch off the power supply and secure it to prevent it from being switched back on.
- Do not jumper or disable any fuses or circuit breakers. When replacing fuses or circuit breakers make sure to adhere to the correct ampere rating.
- Keep moisture away from live parts. It can lead to a short circuit.

## Moving parts



### **WARNING!**

#### **Risk of fatal injury from moving parts.**

Rotating parts and/or parts which move linearly can cause serious injuries.

Therefore:

- Do not reach into moving parts or handle moving parts during operation.
- Do not open covers during operation.
- Adhere to the follow-up time:  
Before opening covers make sure that none of the parts are still moving.
- In the danger area wear close-fitting protective clothing.



## Hot surfaces



### **CAUTION!**

#### **Risk of burns from hot surfaces.**

Contact with hot parts can cause burns.

Therefore:

- When working in the vicinity of hot parts always wear protective clothing and protective gloves.
- Before carrying out any work make sure that all components have cooled to ambient temperature.

## Soiling and objects lying around



### **CAUTION!**

#### **Risk of stumbling due to soiling and objects left lying around.**

Soiling and objects left lying around are sources of slipping and stumbling and can cause considerable injuries.

Therefore:

- Always keep the working area clean.
- Remove any objects which are no longer required.
- Mark any possible stumbling hazards with yellow and black marker tape.

## Sharp edges and corners



### **CAUTION!**

#### **Risk of injuries from edges and corners.**

Sharp edges and corners can cause grazes and cuts on the skin.

Therefore:

- Proceed with caution when working in the vicinity of sharp edges and corners.
- If in doubt wear protective gloves.



## 2.6 Safety devices

### Integration into an emergency stop concept required

The machine is for use within a plant. It does not have its own control unit and does not have an independent emergency stop function.

Before the machine is put into operation install the emergency stop devices for the machine and integrate it into the plant control unit's safety chain.

Connect the emergency stop devices so that dangerous situations for people and objects of material value cannot arise if the energy supply is broken or the energy supply is activated after being broken.

The emergency stop devices must be freely accessible at all times.

## 2.7 Securing the machine to prevent it from being switched back on



### **DANGER!** **Risk of death from switching on without authorisation!**

When working in the danger area there is a risk that the energy supply will be switched on without authorisation. This puts the life of people in the danger area at risk.

Therefore:

- Adhere to the instructions on securing the machine to prevent it from being switched on in the chapters of this manual.
- Always adhere to the procedure described below to secure the machine to prevent it from being switched back on.



Switch secured with a padlock

on: ..... at ..... h.

**DO NOT SWITCH ON**

The padlock must only be removed

by: .....

after having ensured that there is nobody in the danger area.

Fig. 2

Switched off

on: ..... at ..... h.

**DO NOT SWITCH ON**

Only

.....

is allowed to switch on after having ensured that there is nobody in the danger area.

Fig. 3

### Securing the machine to prevent it from being switched back on:

1. Switch off the energy supply.
2. If possible, secure the switch with a padlock and attach a clearly visible sign according to Fig. 2 to the switch.
3. Have the key kept safely by the member of staff named on the sign.
4. If it is impossible to secure a switch with a padlock, erect a sign according to Fig. 3.
5. Once all work has been carried out, make sure that nobody is in the danger area.
6. Make sure that all safety devices and mechanisms are installed and fully functional.
7. Do not remove the sign until you have done so.

## 2.8 How to act in case of hazards and accidents

### Preventive measures

- Always be prepared for accidents or fires.
- Keep first aid facilities (first aid box, blankets etc.) and fire extinguishers accessible at all times.
- Familiarise staff with accident report, first aid and rescue facilities.
- Keep access routes for emergency vehicles clear.

### Measures in case of accidents

- Trigger an emergency stop immediately.
- Instigate first aid measures.
- Remove any people from the danger zone.
- Inform the responsible party at the location.
- Notify emergency services.
- Clear access routes for emergency vehicles.

## 2.9 Environmental protection

**CAUTION!****Risk of environmental damage in case of incorrect handling.**

Incorrect handling of environmentally hazardous substances, in particular incorrect disposal, can cause considerable damage to the environment.

Therefore:

- Always adhere to the instructions below.
- If environmentally hazardous substances are accidentally released into the environment, take suitable measures immediately. In case of doubt inform the responsible local authority of the damage.

The following environmentally hazardous substances are used:

### Lubricants

Lubricants such as grease and oils contain toxic substances. They must not be released into the environment. They must be disposed of by a specialist disposal company.

**NOTE!**

*The motors comply with EC Directive 2011/65/EU for the limitation of the use of certain hazardous substances in electrical and electronic devices.*

### 3 Technical data



#### NOTE!

The necessary technical data can be found on the respective type plates. This information is authoritative.

Further technical data can be taken from the catalogue.

#### 3.1 Operating conditions

##### Environment

Specification	Value	Unit
Temperature range (standard)	-20...+40	°C
Temperature range (optional)	-50...+85	°C
Maximum installation height above sea level	1000	m

The permitted ambient temperature range is only indicated on the type plate if it deviates from the standard.

#### 3.2 Type plate

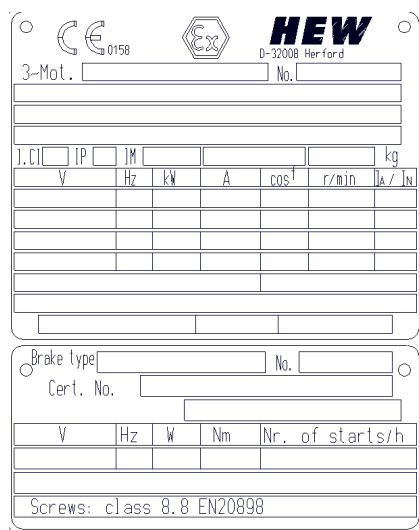

The image shows a detailed type plate for a motor. It includes the following fields and symbols:

- CE mark (0158)
- Explosion protection symbol (EX)
- HEW logo and D-32008 Herford
- 3-Mot. [ ] No. [ ]
- IP [ ] IM [ ] kg
- V [ ] Hz [ ] kW [ ] A [ ] cos φ [ ] r/min [ ] N/A [ ]
- Brake type [ ] No. [ ]
- Cert. No. [ ]
- V [ ] Hz [ ] W [ ] Nm [ ] Nr. of starts/h [ ]
- Screws: class 8.8 EN20898

The type plate is situated on the motor housing and the information it contains includes:

- Explosion protection symbol
- Manufacturer/year of manufacture
- CE symbol
- ID of notified body
- Certificate number
- Motor identification (type), motor number (serial number)
- Weight
- Performance data
- Technical data of the brake
- Ambient temperatures deviating from the standard temperatures of – 20°C to + 40°C specified in the standard

Fig.4: Example of a type plate



#### NOTE!

The information on the type plate may vary depending on the type of motor.

### 3.3 Explosion protection marking



#### EXPLOSION PROTECTION!

acc. to ATEX directive 2014/34/EU

EN 60079 standard or IECEx standard IEC 60079



#### NOTE!

There may be further signs on the machine with various pieces of information.

#### Marking acc. to ATEX



II 2G Ex d IIC T4 – T6 Gb or Ex de IIC T4 – T6 Gb



II 2G Ex d IIB T4 – T6 Gb or Ex de IIB T4 – T6 Gb



II 2D Ex tb IIIC T 135 – 85°C Db

#### Marking acc. to IECEx

Ex d IIC T4 – T6 Gb or Ex de IIC T4 – T6 Gb

Ex d IIB T4 – T6 Gb or Ex de IIB T4 – T6 Gb

Ex tb IIIC T 135 – 85°C Db

Section	Designation	Significance
	Explosion protection symbol	Marking for protection from explosions
II	Device group	Device group II. The motor can be used in potentially explosive areas except in mining.
2	Category	For application in Zone 1 and Zone 21
G D	Explosive atmosphere	... caused by gas. ... caused by dust.
Ex	Standard	Standard on explosion protection
d e t	Ignition protection type	Pressurised enclosure. Increased safety. Protection by housing
IIC / IIB IIIC	Explosion group Dust group	Maximum experimental safe gap (MESG) Type and shape
T4 – T6	Temperature class	maximum surface temperature present T4 (135 °C) – T6 (85 °C)



Section	Designation	Significance
Gb / Db	Equipment protection level	Equipment category acc. to IEC standard

## 4 Construction and function

### 4.1 Overview of sizes 71 to 132

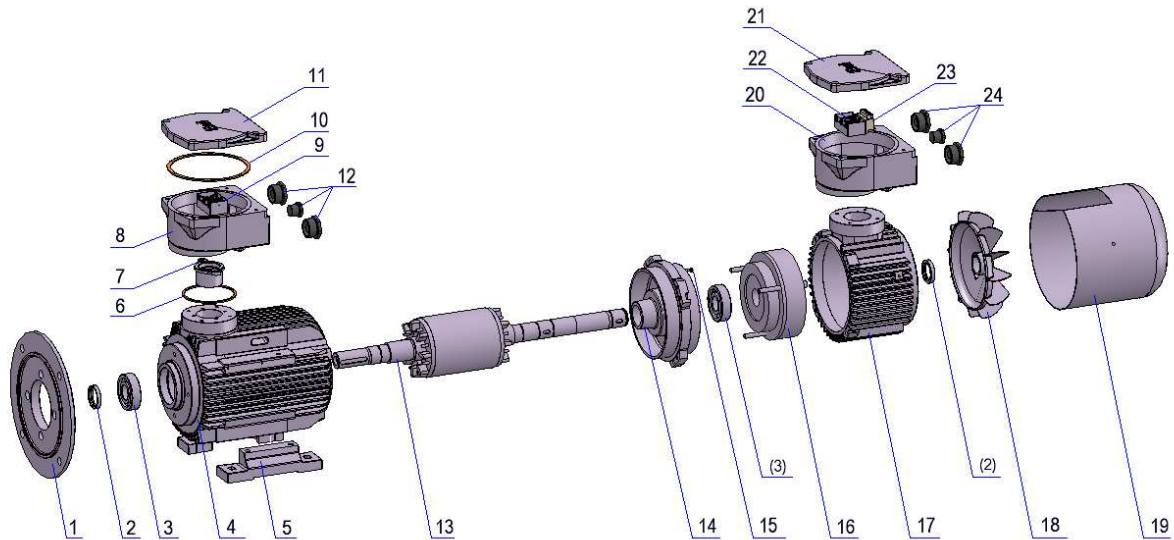

Fig. 5: Overview of sizes 71 to 132

1	Flange ring	13	Rotor shaft, complete
2	Sealing rings DS* <sup>1</sup> + NS* <sup>2</sup>	14	bearing cover NS* <sup>2</sup>
3	Rolling bearings DS* <sup>1</sup> + NS* <sup>2</sup>	15	Temperature monitoring / brake
4	Stator housing, complete	16	Brake with hub and lining
5	Motor foot	17	Bell housing / brake
6	Seal for bottom part of the terminal box / motor	18	Fan blade
7	Cable bushing	19	Ventilation hood (with optional safety cover)
8	Bottom part of the terminal box / motor	20	Bottom part of the terminal box / brake
9	Terminal board / motor	21	Terminal box cover / brake
10	Seal for cover of the terminal box / motor	22	Terminal board / brake
11	Terminal box cover / motor	23	Rectifier
12	Cable gland / motor	24	Screwed cable gland

\*<sup>1</sup> DS = Drive side

\*<sup>2</sup> NS = Nondrive side

## 4.2 Description of the brake

### 4.2.1 General description

The motor is equipped with an electromagnetic brake. In the deenergised state, pressure springs generate the braking torque. To release the brake, a direct current excites the solenoid of the magnet part and the resulting magnetic field pulls the armature disc against the spring force to the magnet part. The rotor is no longer subjected to the spring force and can turn freely.

The maximum braking torque can be reduced by reducing the pressure springs.

### 4.2.2 Assignment and technical data

Size / Type	Braking torque [Nm]	Max. speed rpm	Power $P_{20^{\circ}\text{C}}$ [W]	Moment of inertia [ $\text{kgm}^2 \cdot 10^{-4}$ ]	Weight [kg]
B_Ex 71-BM5	5	6000	22	0.13	1
B_Ex 80-BM10	10	6000	28	0.45	2
B_Ex 90-BM20	20	6000	34	1.6	3
B_Ex 100-BM40	40	6000	42	3.6	5
B_Ex 112-BM60	60	3600	50	4.7	6.5
B_Ex 132-BM100	100	3600	76	11.0	10.0

The brake voltage is indicated on the type plate (standard: 24V, 48V, 180V or 205V).

The brake motors come in two basic circuit variants.

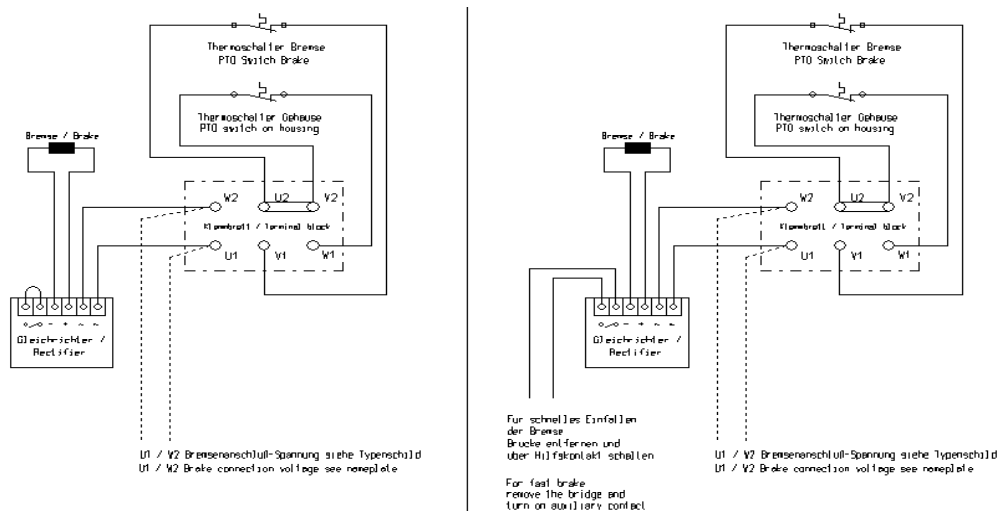

#### AC switching:

This results in a smooth, delayed brake engagement

#### DC switching:

Reduces the brake engagement time

## 4.3. Connection and protection of the motor or brake



**Before connecting the explosion protected motor, check the following:**

- **do the ratings on the type plate match the mains voltage and frequency?**
- **does the explosion protection match the environment in which the motor is operated (group, temperature class, surface temperature)?**

The electrical connections are established using the terminal box. The connection diagram (wiring diagram) is inside the terminal box.

Optionally the motors can be supplied with a motor cable instead of with a terminal box (⇒ catalogue).

If a standstill heating is present, the electrical controller has to ensure that the motor voltage and the heating voltage cannot be applied simultaneously.

The motor protection can be implemented with a motor protection switch or thermal sensors (thermistor, thermostatic switch/bi-metal, PT100).

For self-ventilated, single-speed motors in S1 operation with low-load and infrequent starts not causing any significant heating, a motor protection switch is a sufficient measure to comply with explosion protection requirements (temperature class).

For all modes other than the above-named mode, exclusive protection by temperature monitoring with a thermal sensor in connection with a certified triggering device is mandatory. These triggering devices must have been certified and marked by a notified body according to directive 2014/34/EU. The devices must be included in the regular monitoring by the operator.

The brake is always protected by two thermostatic switches PTO (bi-metal) that are monitoring the temperature increase of the brake coil or the brake bearing cover. This ensures adherence to the specified temperature class. The thermostatic switches are to be connected in the terminal box of the brake (see wiring diagram). Brake protection must be included in the overall drive control.

#### **4.4 Obligations and conditions**

Some gap lengths of the spark-proof gap of this equipment are greater, and some gap widths of the spark-proof gap are smaller than required in Table 2 of EN/IEC 60079-1:2007. For information regarding the dimensions, please contact the manufacturer.

To connect the pressure proof encapsulation, use screws with a yield point of at least 640 N/mm<sup>2</sup>.

Motors requiring direct temperature monitoring have to be monitored with a separately certified triggering device (see 4.3).

Make sure when operating a 3-phase motor with an external fan that the motor can only be run while the external fan is running. The external fan motor must comply with EPL Gb or Db.

Make sure not to exceed the permissible temperatures for the used components.

Only metal fan blades may be used if the temperature on the shaft journal in the fan blade area is  $\geq 95^{\circ}\text{C}$  during rated operation.

The manufacturer specifies the electrical parameters, the temperature class and the ambient temperature range of the respective version after a routine test.

Make sure to connect all wire connections to the terminal board using appropriate cable lugs.

Only use tightening torque values according to those indicated in chapter 9.4.1.



### 4.5 Operation on the frequency inverter

The motors of EX versions pressure-proof encapsulation Ex d(e) and protection by housing Ex t are approved for inverter operation. For approved versions, the possible frequency range must be obtained from the EC prototype test certificate.

The chart and the table below show and explain the most common curves for FI operation. The permissible torque at 50 Hz depends on the size, the number of poles and the performance; refer to the HEW catalogue “Explosion protected electric motors” (Part 20).

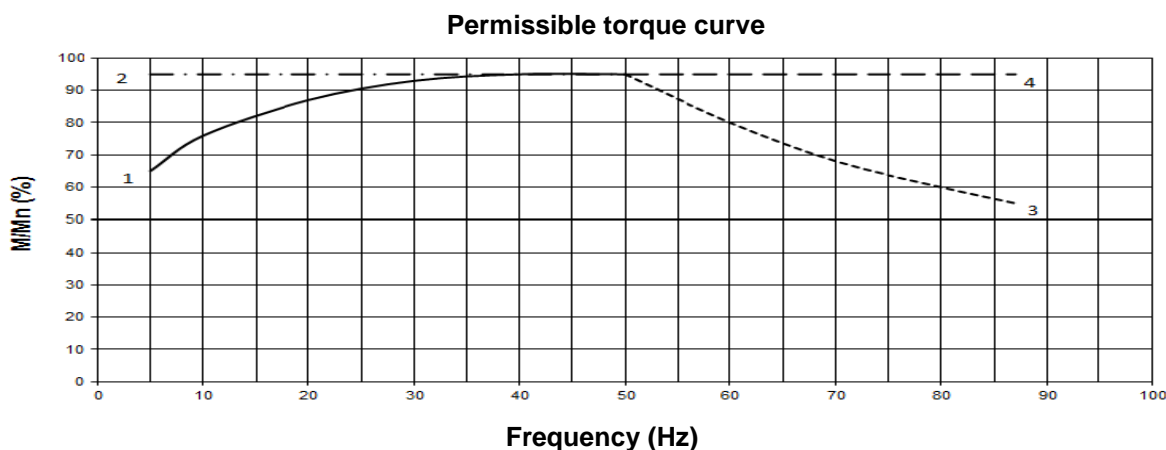

Characteristic curve	Frequency	Motor Version	Motor Voltage / circuit	Inverter	Ventilation	Torque curve in frequency range acc. to catalogue part 20
1	5 - 50 Hz	230/400 V 400/690V	400 V Y 400 V Δ	U/f=constant U/f=constant	internal fan	reduced
2	5 - 50 Hz	230/400 V 400/690V	400 V Y 400 V Δ	U/f=constant U/f=constant	external ventilation	constant
3	50 - 87Hz	230/400 V 400/690V	400 V Y 400 V Δ	U=constant U=constant	internal fan	drops with 1/f Field weakening operation
4	50 - 87Hz	230/400 V	230V Δ	U/f=constant	internal fan	constant 87 Hz curve

When the frequency range is specified in the order, the motors come with an additional plate indicating the FI operation data given on the right (example: B\_Ex 112 M/4 K – 400V Δ 50Hz 4.0kW )

B\_Ex 112 M/4 K / FI operation: Δ– circuit  
 40 V 5 Hz 0.24 kW Tperm.= 16 Nm  
 400 V 50 Hz 4.0 kW Tperm.= 27 Nm  
 400 V 87Hz 4.0 kW Tperm.= 16Nm

Sections 4.3 and 4.4 describe the motor protection for frequency inverter operation. We recommend using shielded cables to prevent electromagnetic interference. For motors of size 250 and greater we recommend



using insulated bearings. Further information can be requested from the HEW headquarters in Herford at any time.

## 5 Transportation, packaging and storage

### Suspended loads



#### **WARNING!**

#### **Risk of fatal injury from suspended loads.**

When lifting loads there is a risk of fatal injuries from falling parts or parts swinging uncontrolledly.

Therefore:

- Never stand under suspended loads.
- Only use the stipulated fastening points.
- Do not fasten lifting gear to protruding machine parts or the lugs on attached parts. Make sure the fastening equipment is securely fastened.
- Only use approved lifting gear and fastening equipment with sufficient load bearing capacity.
- Do not use any torn or frayed ropes or belts.
- Do not attach ropes and belts to sharp edges and corners. Do not knot or twist them.

### Off-centre centre of gravity



#### **WARNING!**

#### **Risk of falling due to an off-centre centre of gravity.**

Packages may have an off-centre centre of gravity. If fastened incorrectly the package may tilt and cause potentially fatal injury.

Therefore:

- Adhere to the markings on the packages.
- Attach the crane hook so that it is directly above the centre of gravity.
- Lift cautiously and observe whether the load tilts. If necessary change the fastening.

## Improper transportation



### **CAUTION!** Risk of damage in case of improper transportation.

Improper transportation can cause considerable material damage.

Therefore:

- When unloading delivered packages and when transporting on the premises, proceed with caution and adhere to the symbols and instructions on the packaging.
- Only use the fastening points provided.
- Do not remove the packaging until shortly before installation.

## 5.1 Delivery inspection

Inspect the delivery for damage and to make sure it is complete immediately after receiving it.

Proceed as follows in case of visual external damage:

- Refuse delivery or accept delivery provisionally.
- Make a note of the extent of damage in the shipping documents or on the carrier's delivery note.
- Make a claim.



### **NOTE!**

*Make a claim for every discrepancy as soon as it is discovered. Claims for compensation can only be asserted within the valid claims periods.*

## Explosion protection



### **EXPLOSION PROTECTION!**

Transport damage can cause a loss of the explosion protection.

- Do not put the machine into operation in case of visible transport damage. Contact the manufacturer.

Failure to adhere to these instructions will lead to a loss of the explosion protection.

## 5.2 Transportation

### Fastening points

- Use suitable lifting gear.
- Use the lifting eyebolts provided on the motor.
- To transport machine sets (e.g. gear units, fan attachments etc.) only use the lifting eyebolts and lugs provided. Machine sets must not be lifted by the individual machines.
- Remove any transport safety devices which protect from bearing damage before commissioning.

### Transporting packages by crane

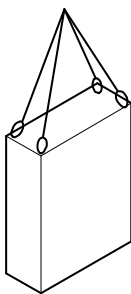

Fig. 6

Packages which have fastening eyebolts can be transported directly by crane on the following conditions:

- The crane and lifting gear must be designed for the weight of the packages.
- The operator must be authorised to operate the crane.

#### Fastening:

1. Fasten ropes, belts or multiple-point suspension gear according to Fig. 6.
2. Make sure that the package hangs straight, paying attention to the off-centre centre of gravity as necessary.
3. Begin transportation.

### Transporting pallets by crane

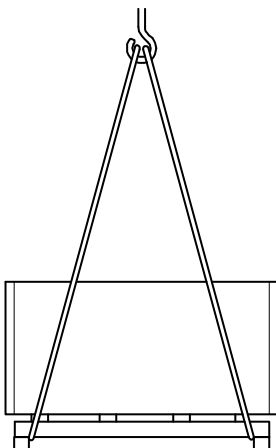

Fig. 7

Packages which are fastened to pallets can be transported by crane under the following conditions:

- The crane and lifting gear must be designed for the weight of the packages.
- The operator must be authorised to operate the crane.

#### Fastening:

1. Fasten ropes, belts or multiple-point suspension gear to the pallet according to Fig. 7.
2. Check that the packages are not damaged by the fastening equipment. If necessary use other fastening equipment.
3. Begin transportation.

### Transporting pallets by forklift

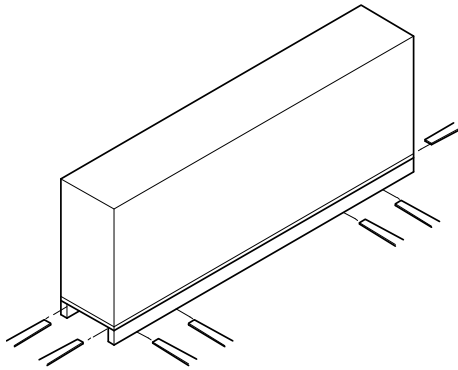

Fig. 8

Packages which are fastened to pallets can be transported by forklift under the following conditions:

- The forklift must be designed for the weight of the units for transportation.
- The driver must be authorised to drive the forklift.

#### Fastening:

1. Drive the forklift with the forks between or underneath the beams of the pallet.
2. Insert the forks so that they protrude on the opposite side.
3. Make sure that the pallet cannot tilt in case it has an off-centre centre of gravity.
4. Raise the package and begin transportation.

## 5.3 Packaging

### Information on packaging

The individual packages are packaged appropriately for the expected transportation conditions. Only environmentally friendly materials have been used for packaging.

The packaging is designed to protect the individual parts from transport damage, corrosion and other damage up until they are installed. You must therefore not destroy the packaging and not remove it until shortly before installation.

### Handling packaging materials

Dispose of packaging material in accordance with the respective valid laws and local regulations.



#### **CAUTION!**

**Risk of environmental damage due to incorrect disposal.**

Packaging materials are valuable raw materials and can be re-used in many cases or treated and recycled.

Therefore:

- Dispose of packaging material in an environmentally friendly manner.
- Adhere to the valid local regulations for disposal. Contract a specialist company to carry out disposal as necessary.



## 5.4 Storage

### Storing packages

Store the packages under the following conditions:

- Do not store in the open.
- Keep in a dry and dust-free environment.
- Do not expose to any corrosive media.
- Protect from sunlight.
- Make sure to store in a low-vibration environment ( $v_{\text{eff}} \leq 0.2$  mm/s)
- Avoid large fluctuations in storage temperature.
- Relative humidity: max. 60 %.
- Check the insulation resistance as necessary (⇒ chapter "Checking the insulation resistance").
- Grease or replace the rolling bearings as necessary (⇒ chapter "Maintenance").
- When storing for longer than 3 months, regularly check the general condition of all parts and the packaging. If necessary, replenish or replace the conservation.



#### **NOTE!**

*In some cases there will be instructions for storage on the packages informing you of further requirements going beyond those listed here. Adhere to these instructions accordingly.*



## 6 Installation and commissioning

**NOTE!**

*When installing and commissioning adhere to the current standards and directive for electrical apparatus for explosive gas atmospheres.*

### 6.1 Safety

**Staff**

- Installation and commissioning must only be performed by specialist staff with the appropriate qualifications.
- Work on the electrical equipment must only be carried out by qualified electricians.

**Personal safety equipment and clothing**

Wear the following safety equipment and clothing for all installation and commissioning work:

- Occupational safety clothing
- Safety shoes

**Explosion protection****EXPLOSION PROTECTION!**

The introduction of ignition sources such as sparks, open flames and hot surfaces can cause explosions in the potentially explosive area.

Therefore, when carrying out all installation work on the machine in the potentially explosive area:

- Do not start any installation work without a written permit.
- Only carry out installation work to the exclusion of a potentially explosive atmosphere.
- Only use tools which are approved for use in the potentially explosive area.

Failure to adhere to these instructions will lead to a loss of the explosion protection.



## Electrical equipment



### **DANGER!**

#### **Danger to life from electrical current.**

There is a risk of fatal injury from contact with live parts. Electrical components which are switched on can carry out uncontrolled movements and cause serious injuries.

Therefore:

- Before starting work switch off the electrical power supply and secure it to prevent it from being switched back on.

## Securing the machine to prevent it from being switched back on



### **DANGER!**

#### **Risk of death from switching on without authorisation!**

When performing installation there is a risk that the energy supply will be switched on without authorisation. This puts the life of people in the danger area at risk.

Therefore:

- Before beginning all work shut off all energy supplies and secure them to prevent them from being switched back on.

## Improper installation and commissioning



### **WARNING!**

#### **Risk of injuries from improper installation and commissioning.**

Improper installation and commissioning can cause serious personal injury and material damage.

Therefore:

- Before starting work make sure there is sufficient space for performing the installation work.
- Handle open, sharp-edged parts with care.
- Keep the installation area clean and tidy. Loose parts and tools stacked on top of each other or parts and tools left lying around are potential sources of accidents.
- Fit parts properly. Adhere to the stipulated tightening torque values for screws.
- Secure parts to prevent them from falling or toppling.

## 6.2 Installation

### 6.2.1 Ventilation at the location for use

The ventilation for the motor must not be obstructed.

You must therefore adhere to the following points:

- Make sure that there is sufficient space between the motor fan and the walls and other similar obstructions.
- The clearance to obstructions must be at least  $d/4$  ( $d$  = diameter of the motor).
- Make sure that the exhaust air is not sucked directly back in.
- In case of heavy soiling clean the air ways regularly.

### 6.2.2 Types of construction as per EN 60034-7

Type of construction and IM code (international mounting) of the most frequently used versions.

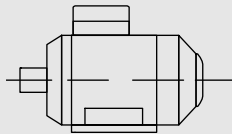
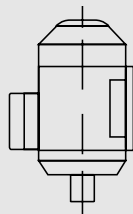
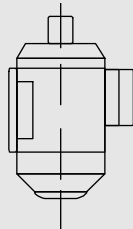
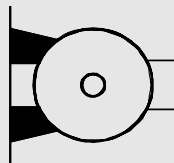
Type of construction	Symbol	Explanation
IM B3 IM 1001		<ul style="list-style-type: none"> <li>■ 2 bearing covers</li> <li>■ with feet</li> </ul>
IM V5 IM 1011		<ul style="list-style-type: none"> <li>■ 2 bearing covers</li> <li>■ with feet</li> <li>■ Shaft end bottom</li> <li>■ Fastening on the wall</li> </ul>
IM V6 IM 1031		<ul style="list-style-type: none"> <li>■ 2 bearing covers</li> <li>■ with feet</li> <li>■ Shaft end top</li> <li>■ Fastening on the wall</li> </ul>
IM B6 IM 1051		<ul style="list-style-type: none"> <li>■ 2 bearing covers</li> <li>■ with feet</li> <li>■ Construction type IM B3</li> <li>■ Fastening on the wall</li> <li>■ Feet left, viewed from drive side</li> </ul>

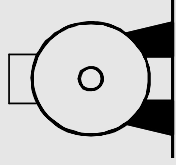
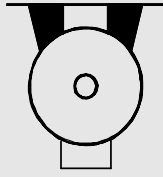
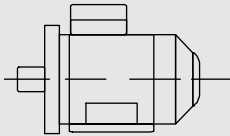
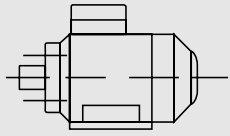
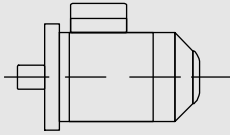
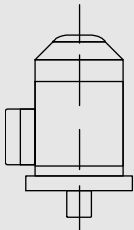
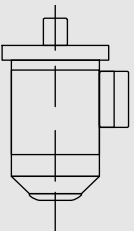
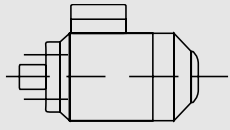
Type of construction	Symbol	Explanation
IM B7 IM 1061		<ul style="list-style-type: none"> <li>■ 2 bearing covers</li> <li>■ with feet</li> <li>■ Construction type IM B3</li> <li>■ Fastening on the wall</li> <li>■ Feet right, viewed from drive side</li> </ul>
IM B8 IM 1071		<ul style="list-style-type: none"> <li>■ 2 bearing covers</li> <li>■ with feet</li> <li>■ Construction type IM B3</li> <li>■ Fastening on the ceiling</li> </ul>
IM B35 IM 2001		<ul style="list-style-type: none"> <li>■ 2 bearing covers</li> <li>■ with feet</li> <li>■ Securing flange type A</li> </ul>
IM B34 IM 2101		<ul style="list-style-type: none"> <li>■ 2 bearing covers</li> <li>■ with feet</li> <li>■ Securing flange type C</li> </ul>
IM B5 IM 3001		<ul style="list-style-type: none"> <li>■ 2 bearing covers</li> <li>■ without feet</li> <li>■ Securing flange type A</li> </ul>
IM V1 IM 3011		<ul style="list-style-type: none"> <li>■ 2 bearing covers</li> <li>■ without feet</li> <li>■ Shaft end bottom</li> <li>■ Securing flange type A</li> </ul>
IM V3 IM 3031		<ul style="list-style-type: none"> <li>■ 2 bearing covers</li> <li>■ without feet</li> <li>■ Shaft end top</li> <li>■ Securing flange type A</li> </ul>
IM B14 IM 3601		<ul style="list-style-type: none"> <li>■ 2 bearing covers</li> <li>■ without feet</li> <li>■ Securing flange type C</li> </ul>

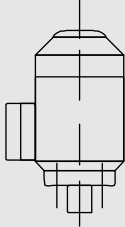
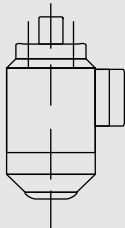
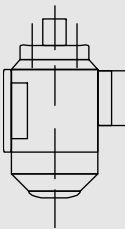
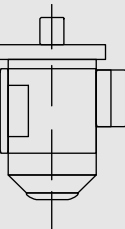
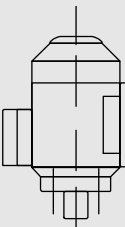
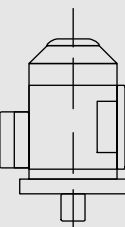
Type of construction	Symbol	Explanation
IM V18 IM 3611		<ul style="list-style-type: none"> <li>■ 2 bearing covers</li> <li>■ without feet</li> <li>■ Shaft end bottom</li> <li>■ Securing flange type C</li> </ul>
IM V19 IM 3631		<ul style="list-style-type: none"> <li>■ 2 bearing covers</li> <li>■ without feet</li> <li>■ Shaft end top</li> <li>■ Securing flange type C</li> </ul>
IM V6/IM V19		<ul style="list-style-type: none"> <li>■ 2 bearing covers</li> <li>■ with feet</li> <li>■ Shaft end top</li> <li>■ Securing flange type C</li> </ul>
IM V36 IM 2031		<ul style="list-style-type: none"> <li>■ 2 bearing covers</li> <li>■ with feet</li> <li>■ Shaft end top</li> <li>■ Securing flange type A</li> </ul>
IM V5/IM V18		<ul style="list-style-type: none"> <li>■ 2 bearing covers</li> <li>■ with feet</li> <li>■ Shaft end bottom</li> <li>■ Securing flange type C</li> </ul>
IM V15 IM 2011		<ul style="list-style-type: none"> <li>■ 2 bearing covers</li> <li>■ with feet</li> <li>■ Shaft end bottom</li> <li>■ Securing flange type A</li> </ul>

### 6.2.3 Erecting the machine

**DANGER!****Risk of death due to insufficient protection classes.**

Insufficient protection classes can lead to considerable material damage, serious personal injury or even death.

Therefore:

- Do not erect machines of protection class  $\leq$  IP23 in the open.

In order to ensure that the machine runs quietly and with low vibrations make sure of the following when erecting the machine:

- the foundation must be stable
- the foundation's natural frequency with the machine must be sufficiently different to the rotary frequency and the double mains frequency
- the motors must be aligned accurately
- the drive machines must be well balanced

### 6.2.4 Installation

Installation varies depending on the construction type. In case you have any doubts contact the service department ( $\Rightarrow$  page 2).

When installing, always pay attention to the following points:

- All connection elements (walls, ceilings etc.) must be of sufficient size.
- The rotor is dynamically balanced with a half feather key. Take this into account when balancing the drive element.
- Avoid incorrect belt tension ( $\Rightarrow$  catalogue). Cover couplings and belt pulleys with a guard to protect accidental contact.
- Fit and remove drive elements (couplings, belt pulley, toothed wheels etc.) with the suitable devices.
- Tighten all screw connections with the appropriate tightening torque ( $\Rightarrow$ chapter "Tightening torque values for screws").
- Fit construction types with the shaft ends at the bottom with a cover to prevent foreign bodies from falling into the motor's fan.
- Any condensation drain holes must be positioned at the lowest point of the motor when installed and cleaned of any impurities.
- Take generally required measures for preventing accidental contacts between drive elements

## 6.3 Connecting to the energy supply

### Electrical current



#### **DANGER!**

#### **Danger to life from electrical current.**

There is an immediate risk of fatal injury in case of contact with live parts. Damage to the insulation or individual components can mean danger to life.

Therefore:

- In case of damage to the insulation, switch off the power supply immediately and have repairs carried out.
- Have work on the electrical equipment carried out by qualified electricians only.
- When any work is carried out on the electrical equipment, disconnect it from the power and make sure it is free of voltage.
- Before carrying out maintenance, cleaning and repair work, switch off the power supply and secure it to prevent it from being switched back on.
- Do not jumper or disable any fuses or circuit breakers. When replacing fuses or circuit breakers make sure to adhere to the correct ampere rating.
- Keep moisture away from live parts. It can lead to a short circuit.

### 6.3.1 Screwed cable gland



#### **NOTE!**

*Type Ex de motors are equipped with EEx e screwed cable glands. For type EEx d motors, the cable glands are not included in the scope of delivery. These must be adapted to the cable diameter on site.*



#### **NOTE!**

*Unused cable bushing openings must be sealed off with certified plugs with the matching IP protection type as shown on the type plate.*

**Ex d motors**

1. Connection to the terminal box with these motors is implemented with a standard connection.
2. You must take great care when selecting the cable connection. It is imperative that the version is approved and approved for at least the protection class of the motor.
3. The type and dimensions of the cable connections must match the cable type and cable cross section.

**Ex de motors**

1. Strictly adhere to the directives and standards which apply to the terminal box connections of these motors. The type of cable connection must be approved.
2. Make sure that the supply cable is connected in line with the instructions of the wiring diagram in the terminal box.
3. Properly insert the seals on the terminal box into the grooves provided.
4. Creepage paths and air gaps must comply with EN 60079-7.

**6.3.2 Voltage and circuit**

- Adhere to the wiring specification on the type plate and wiring diagram in the terminal box.
- Compare the operating voltages and supply voltages.
- Motor rated voltage and the supply voltage must not differ  $\pm 5\%$ ;  $\pm 2\%$  is permitted for the rated frequency.
- Brake rated voltage  $\pm 5\%$



### 6.3.3 Checking the insulation resistance

- To be performed by a qualified electrician only

**DANGER!****Risk of death due to uncontrolled fault currents.**

Insulation faults can call potentially fatal fault currents.

Therefore:

- The value of the insulation resistance must be higher than the critical value of 0.5 MΩ.
- In case the value drops below the critical insulation resistance, take the motor out of operation and shut it down immediately.

**DANGER!****Danger to life from electrical current.**

When measuring and immediately afterwards the terminals carry partly dangerous voltages.

Therefore:

- Do not touch the terminals.
- Discharge after measuring.

Before commissioning the motor, after a longer period of storage or without use, the insulation resistance of the coils has to be determined again. When doing so, adhere to the valid standards and directives.

### 6.4 Commissioning

**DANGER!****Danger to life from electrical current.**

There is an immediate risk of fatal injury in case of contact with live parts.

Therefore:

- Only carry out work with the plant free of voltage.
- Secure the plant to prevent it from being switched back on.

**CAUTION!**

**Risk of personal injury and/or material damage from feather keys ejected at speed.**

When commissioning a motor without drive elements the feather keys may be ejected at speed.

Therefore:

- Before commissioning motors without drive elements remove or secure the feather keys beforehand.

Before commissioning make sure that:

- the minimum insulation resistance values are adhered to (⇒ chapter "Checking the insulation resistance").
- the protective earth conductor connection is properly established and, where necessary, a potential equalisation has been established (see DIN EN 60079-14, chapter 6.3)
- the rotor can be turned without rubbing.
- the motor is properly fitted and aligned.
- the drive elements have the right settings (e.g. belt tension for belt drive etc.)
- the drives are suitable for the conditions of use.
- all electrical connections, fastening screws and fastening elements are the right type and are tightened properly.
- measures to prevent accidental contacts for moving and live parts have been taken.

**NOTE!**

*Commissioning is performed using the overall plant control unit (⇒ Operating manual for the complete plant).*

## 7 Operations

### 7.1 General information

During operation no staff are required in the machine area or in the direct vicinity to operate it.

Operation is performed using the overall plant control unit (⇒ Operating manual for the complete plant).

### 7.2 Shutting down in an emergency

In danger situations machine movements must be stopped as quickly as possible and the energy supply has to be switched off.

#### Shutting down in an emergency

In case of danger proceed as follows:

1. Trigger an emergency stop immediately.
2. Remove any people from the danger zone and administer first aid.
3. Alert a doctor and the fire services.
4. Inform the responsible party at the location.
5. Switch off the master switch and secure it to prevent it from being switched back on.
6. Keep access routes for emergency vehicles clear.
7. If the seriousness of the emergency requires it, inform the respective authorities.
8. Have specialist staff remedy the fault.

#### After emergency measures



#### **WARNING!**

#### **Risk of death from switching on prematurely.**

When switching back on there is a risk of fatal injury for all people in the danger area.

Therefore:

- Before switching back on make sure that there is nobody in the danger area.

9. Before re-starting check the plant and make sure that all safety devices are installed and fully functional.



## 8 Faults

The following chapter describes possible causes of faults and the work to eradicate them.

In case of faults which occur several times, reduce the maintenance interval accordingly to suit the actual strain.

In case of faults which cannot be cleared using the following instructions, contact the manufacturer, see service address on page 2.

### 8.1 Safety

#### Staff

- Some tasks can only be carried out by specialist staff with special qualifications or exclusively by the manufacturer. The description of the respective individual fault makes reference to this in each case.
- Work on the electrical equipment must only be carried out by qualified electricians.

#### Personal safety equipment and clothing

Wear the following safety equipment and clothing for all faults work:

- Occupational safety clothing
- Safety shoes

#### Explosion protection



#### EXPLOSION PROTECTION!

The introduction of ignition sources such as sparks, open flames and hot surfaces can cause explosions in the potentially explosive area. Therefore, when carrying out all work to remedy faults in the potentially explosive area:

- Do not start any work without a written permit.
- Only carry out work to remedy faults to the exclusion of a potentially explosive atmosphere.
- Only use tools which are approved for use in the potentially explosive area.

Failure to adhere to these instructions will lead to a loss of the explosion protection.

## Electrical equipment



### **DANGER!**

#### **Danger to life from electrical current.**

There is a risk of fatal injury from contact with live parts. Electrical components which are switched on can carry out uncontrolled movements and cause serious injuries.

Therefore:

- Before starting work switch off the electrical power supply and secure it to prevent it from being switched back on.

## Securing the machine to prevent it from being switched back on



### **DANGER!**

#### **Risk of death from switching on without authorisation!**

When working to remedy faults there is a risk that the energy supply will be switched on without authorisation. This puts the life of people in the danger area at risk.

Therefore:

- Before beginning all work shut off all energy supplies and secure them to prevent them from being switched back on.

## Improper eradication of faults



### **WARNING!**

#### **Risk of injuries from incorrectly eradicating faults.**

Eradicating faults incorrectly can cause serious personal injury and material damage.

Therefore:

- Before starting work make sure there is sufficient space for performing the installation work.
- Keep the installation area clean and tidy. Loose parts and tools stacked on top of each other or parts and tools left lying around are potential sources of accidents.
- If parts have been removed, make sure they are installed properly, re-install all fastening elements and adhere to the tightening torque values for screws.



## How to act in case of faults

The following basic instructions apply:

1. In case of faults which pose an immediate risk to people or objects of material value, activate the emergency stop function immediately.
2. Determine the cause of the fault.
3. If eradicating the fault requires work in the danger area, switch off the plant and secure it to prevent it from being switched back on.
4. Inform the responsible party at the location of the fault immediately.
5. Depending on the type of fault, have it remedied by specialist staff or remedy it yourself.



### NOTE!

The following fault table provides information on who is authorised to remedy the fault.

## 8.2 Fault table

Fault	Possible cause	Remedy	To be remedied by
■ Bearing is too warm	Too much grease in the bearing	Remove excessive grease	Qualified specialist
	Bearing is soiled	Replace the bearing	Manufacturer
	Belt tension too high	Reduce belt tension	Qualified specialist
	Bearing grease dark in colour	Check for bearing currents	Qualified specialist
■ Bearing is too warm ■ Motor is not running smoothly	Coupling forces are pulling or pushing	Align the motor exactly, adjust the coupling	Qualified specialist
■ Bearing is too warm ■ Bearing noises	Not enough grease in the bearing	Lubricate as stipulated	Qualified specialist
■ Bearing is too warm ■ Bearing noises ■ Motor is not running smoothly	Motor erected incorrectly	Check the motor construction type	Qualified specialist

Fault	Possible cause	Remedy	To be remedied by
<ul style="list-style-type: none"> <li>■ Bearing noises</li> </ul>	Scoring on inner bearing ring, e.g. from motor starting up with bearing locked	Replace bearing, avoid vibrations when at a standstill	Manufacturer
<ul style="list-style-type: none"> <li>■ Motor is not running smoothly</li> </ul>	Imbalance due to belt pulley or coupling	Balance exactly	Manufacturer
	Machine fastening insufficient	Check machine fastening	Qualified specialist
<ul style="list-style-type: none"> <li>■ Motor does not start up</li> <li>■ Considerable drop in speed</li> </ul>	Load moment too high	Check motor torque and load moment	Qualified electrician
	Supply voltage too low	Check power supply conditions	Qualified electrician
<ul style="list-style-type: none"> <li>■ Motor does not start up</li> <li>■ Considerable drop in speed</li> <li>■ Safety device is triggered</li> </ul>	Phase interrupted	Check the mains connection	Qualified electrician
<ul style="list-style-type: none"> <li>■ Motor does not start up</li> <li>■ Motor is too warm</li> <li>■ Considerable drop in speed</li> <li>■ Safety device is triggered</li> </ul>	Incorrect circuit	Adhere to wiring diagram and type plate	Qualified electrician
<ul style="list-style-type: none"> <li>■ Motor is too warm</li> <li>■ Considerable drop in speed</li> <li>■ Safety device is triggered</li> </ul>	Overload	Adhere to stipulations on type plate	Qualified electrician
<ul style="list-style-type: none"> <li>■ Motor is too warm</li> <li>■ Safety device is triggered</li> </ul>	Too many switching actuations	Observe rated operating mode	Qualified electrician
<ul style="list-style-type: none"> <li>■ Motor is too warm</li> </ul>	Ventilation insufficient	Check cooling air routes, check direction of rotation	Qualified electrician
	Ventilation ducts soiled	Clean the ventilation ducts	Qualified specialist
<ul style="list-style-type: none"> <li>■ Safety device is triggered</li> </ul>	Coil or terminal short circuit	Measure the insulation resistance	Qualified electrician
	The start-up time has been exceeded	Check the start-up conditions	Qualified electrician



Fault	Possible cause	Remedy	To be remedied by
■ Brake does not release	Wrong brake voltage	Change brake coil	Qualified electrician
	Rectifier faulty	Replace rectifier	Qualified electrician



### 8.3 Commissioning after remedied fault

After remedying the fault carry out the following steps for re-commissioning:

1. Reset the emergency stop devices.
2. Acknowledge the fault on the control unit.
3. Make sure that there is nobody in the danger area.
4. Start by following the instructions in the chapter "Operation".

#### Explosion protection



#### **EXPLOSION PROTECTION!**

Introducing ignition sources such as sparks in the potentially explosive area can cause explosions. Therefore, after carrying out all work to remedy faults in the potentially explosive area:

- Make sure that all aggregates are connected to each other with potential equalisation of sufficient dimensions. To be performed by a qualified electrician only.
- Make sure that the motor is earthed to prevent static charging. To be performed by a qualified electrician only.

Failure to adhere to these instructions will lead to a loss of the explosion protection.



## 9 Maintenance

### 9.1 Safety

#### Staff

- The maintenance work described here can be carried out by the operator unless otherwise stated.
- Some maintenance tasks can only be carried out by specialist staff with special qualifications or exclusively by the manufacturer. The description of the respective individual maintenance task makes reference to this in each case.
- Work on the electrical equipment must only be carried out by qualified electricians.

#### Personal safety equipment and clothing

Wear the following safety equipment and clothing for all maintenance work:

- Occupational safety clothing
- Safety shoes

#### Explosion protection



#### **EXPLOSION PROTECTION!**

The introduction of ignition sources such as sparks, open flames and hot surfaces can cause explosions in the potentially explosive area. Therefore, when carrying out all maintenance work on the machine in the potentially explosive area:

- Do not start any maintenance work without a written permit.
- Only carry out maintenance work to the exclusion of a potentially explosive atmosphere.
- Only use tools which are approved for use in the potentially explosive area.

Failure to adhere to these instructions will lead to a loss of the explosion protection.

## Electrical equipment



### **DANGER!**

#### **Danger to life from electrical current.**

There is a risk of fatal injury from contact with live parts. Electrical components which are switched on can carry out uncontrolled movements and cause serious injuries.

Therefore:

- Before starting work switch off the electrical power supply and secure it to prevent it from being switched back on.

## Securing the machine to prevent it from being switched back on



### **DANGER!**

#### **Risk of death from switching on without authorisation!**

When performing maintenance there is a risk that the energy supply will be switched on without authorisation. This puts the life of people in the danger area at risk.

Therefore:

- Before beginning all work shut off all energy supplies and secure them to prevent them from being switched back on.

## Improperly performed maintenance work



### **WARNING!**

#### **Risk of injury due to improperly performed maintenance work.**

Performing maintenance incorrectly can cause serious personal injury and material damage.

Therefore:

- Before starting work make sure there is sufficient space for performing the installation work.
- Keep the installation area clean and tidy. Loose parts and tools stacked on top of each other or parts and tools left lying around are potential sources of accidents.
- If parts have been removed, make sure they are installed properly, re-install all fastening elements and adhere to the tightening torque values for screws.

## Environmental protection

Adhere to the following instructions on environmental protection when performing maintenance work:



- At all lubricating points which are supplied with lubricant by hand, remove the expelled, used or excess grease and dispose of it in accordance with the local regulations.
- Collect replaced oil in suitable containers and dispose of it in accordance with the local regulations.

## 9.2 Cleaning

- Additionally required safety equipment and clothing:
  - Light breathing mask

### Explosion protection



#### EXPLOSION PROTECTION!

Swirled up deposits of dust can form potentially explosive dust/air mixtures and when ignition sources are introduced, such as sparks, open flames and hot surfaces, can cause explosions in the potentially explosive area.

Therefore:

- Prevent layers of dust deposits from exceeding a thickness of 5 mm by regularly cleaning the location.
- Only carry out cleaning work to the exclusion of a potentially explosive atmosphere.
- Only use cleaning implements which are approved for use in the potentially explosive area.
- Wear personal safety equipment and clothing.

Failure to adhere to these instructions will lead to a loss of the explosion protection.

- Do not spray electrical machines with water or other liquids.
- Check the entire route for cooling air for soiling at least once a year.

## 9.3 Maintenance schedule

The next sections describe maintenance work which is required to ensure optimum and fault-free operation.

If during regular checks increased wear is identified, shorten the required maintenance intervals to match the actual signs of wear.

In case you have any questions on maintenance work and intervals, contact the manufacturer, see service address on page 2.

The standard version motors are fitted with permanently lubricated bearings.

## 9.4 Tightening torque values for screws

### Explosion protection



#### EXPLOSION PROTECTION!

The introduction of ignition sources such as sparks, open flames and hot surfaces can cause explosions in the potentially explosive area.

Therefore, when carrying out all maintenance work on the machine in the potentially explosive area:

- Do not start any maintenance work without a written permit.
- Only carry out maintenance work to the exclusion of a potentially explosive atmosphere.
- Only use tools which are approved for use in the potentially explosive area.

Failure to adhere to these instructions will lead to a loss of the explosion protection.



#### NOTE!

**Strength class 8.8 screws must be used for all screwed connections which are used to seal the pressure-resistant space.**

*Replace screws which can no longer be used with new screws of the same type and strength class.*

If not otherwise stated, the following tightening torque values apply for screw connections.



#### 9.4.1 Tightening torque values for screws for electrical connections

Thread	Tightening torque value [Nm]	Thread	Tightening torque value [Nm]
M 4	1.2	M 12	15.5
M 5	2	M 16	30
M 6	3	M 20	52
M 8	6	M 24	80
M 10	10	M 30	150

#### 9.4.2 Screw connections, property class 8.8 and A4-70



**NOTE!**

Only use tightening torque values for screws of property class 8.8 and A4-70 (A4-80) in high-strength parts (e.g. grey cast iron, steel).

Thread	Tightening torque value [Nm]	Thread	Tightening torque value [Nm]
M 4	2.3	M 14	105
M 5	4.6	M 16	160
M 6	7.9	M 20	330
M 8	19	M 24	560
M 10	38	M 30	1100
M 12	66	M 36	1900

#### 9.4.3 Screw connections of property class 5.6



**NOTE!**

Only use tightening torque values for screws of property class 5.6, 4.6 A2 or for screws in low-strength parts (e.g. aluminium).

Thread	Tightening torque value [Nm]	Thread	Tightening torque value [Nm]
M 4	1.1	M 14	49
M 5	2.1	M 16	75
M 6	3.7	M 20	150
M 8	8.9	M 24	260
M 10	18	M 30	520
M 12	30	M 36	920

## 9.5 Measures on completion of maintenance

### Explosion protection



#### EXPLOSION PROTECTION!

Introducing ignition sources such as sparks in the potentially explosive area can cause explosions. Therefore, after carrying out all maintenance work on the machine in the potentially explosive area:

- Make sure that all aggregates are connected to each other with potential equalisation of sufficient dimensions. To be performed by a qualified electrician only.
- Make sure that the motor is earthed to prevent static charging. To be performed by a qualified electrician only.

Failure to adhere to these instructions will lead to a loss of the explosion protection.

On completion of maintenance work, carry out the following steps before switching on:

1. Check that all screw connections which have been unfastened are fastened securely again.
2. Check whether all the safety devices and covers which have been removed have been properly re-installed.
3. Make sure that all tools, materials and other equipment which have been used, have been removed from the working area.
4. Clean the working area and remove any substances, e.g. liquids, processing material etc.
5. Make sure that all the plant's safety devices are in perfect working order.



## 10 Removal

Once the period of use has expired, the machine must be removed and disposed of in an environmentally friendly manner.

### 10.1 Safety

#### Staff

- The machine must only be removed by qualified specialist staff with the appropriate qualifications.
- Work on the electrical equipment must only be carried out by qualified electricians.

#### Explosion protection



##### **EXPLOSION PROTECTION!**

The introduction of ignition sources such as sparks, open flames and hot surfaces can cause explosions in the potentially explosive area. Therefore, when carrying out all removal work on the machine in the potentially explosive area:

- Do not start any removal work without a written permit.
- Only carry out removal work to the exclusion of a potentially explosive atmosphere.
- Only use tools which are approved for use in the potentially explosive area.

Failure to adhere to these instructions will lead to a loss of the explosion protection.

#### Electrical equipment



##### **DANGER!**

##### **Danger to life from electrical current.**

There is a risk of fatal injury from contact with live parts. Electrical components which are switched on can carry out uncontrolled movements and cause serious injuries.

Therefore:

- Before starting removal work switch off the electrical supply and disconnect it permanently.



## Improper removal



### WARNING!

#### Risk of injury from improper removal.

Stored residual energy, sharp parts, points and corners on and in the device or on the required tools can cause injuries.

Therefore:

- Before starting work make sure there is sufficient space.
- Handle open, sharp-edged parts with care.
- Keep the working area clean and tidy. Loose parts and tools stacked on top of each other or parts and tools left lying around are potential sources of accidents.
- Remove parts properly. Be aware that some parts have a heavy dead weight. Use lifting gear as necessary.
- Secure parts to prevent them from falling or toppling.
- In case of doubt, contact the manufacturer.

## 10.2 Removal

Before starting removal:

- Switch off the machine and secure it to prevent it from being switched back on.
- Physically disconnect the entire energy supply from the machine and discharge stored residual energy.
- Remove fuels and consumables and residual processing materials and dispose of them in an environmentally friendly manner.

Then clean assembly groups and parts properly and dismantle then in accordance with the local regulations for occupational safety and environmental protection.



## 10.3 Disposal

If no agreements have been made for return or disposal, have the dismantled components recycled:

- Have metals scrapped.
- Hand over plastic elements for recycling.
- Sort and dispose of other components according to the material properties.



### **CAUTION!**

**Risk of environmental damage due to incorrect disposal.**

Electrical scrap, electronic components, lubricants and consumables require special waste treatment and must only be disposed of by approved specialist companies.

The local authorities or specialist disposal companies can provide information on environmentally friendly disposal.